

Using the AVCS mode correctly

An AVCS gyro is an angular velocity command type gyro. The gyro constantly compares the transmitter rudder operation signals and gyro internal reference signal (transmitter rudder neutral signal) and controls the helicopter tail rotation speed accordingly. Therefore, for the AVCS function to operate normally, the rudder neutral signal must be memorized in the gyro before flight.

•Rudder neutral signal memorization methods

[Method 1] When the gyro power is turned on, the transmitter rudder signal automatically received at that time is assumed to be the neutral signal and is memorized. The gyro is normally used in this state.

[Method 2] Rapidly switch the transmitter sensitivity switch between the AVCS and normal modes at least 3 times at a 1 second or shorter interval, then set the switch to the AVCS mode position. The monitor LED flashes instantaneously and the rudder signal is memorized. If the trimmer was moved during flight, the memorized neutral position can be updated to the current neutral position by repeating this operation. When performing this operation, land the model and hold the rudder stick in the neutral position.

•Rudder neutral check method

In the AVCS mode, the servo does not return to the neutral position even when the rudder stick is returned to the neutral position. When you want to check the servo neutral position during linkage neutral check, etc., select the normal mode, or remain in the AVCS mode, and move the rudder stick left and right at least 3 times at an interval of 1 second or less, then immediately return the stick to the neutral position. This operation returns the rudder servo to the neutral position.

•AVCS mode usage precautions

In the AVCS mode, always set revolution mixing to OFF. If revolution mixing (pitch->rudder mixing) is ON, the pitch operation signal changes the rudder neutral position. The gyro judges that an angular velocity command was received and rotates the tail, therefore, the neutral position changes.

The model flies in the same rudder trim position (including sub trim) as

when the power was turned on (neutral position memorized in the gyro). When flying in the AVCS mode, set the rudder trim to the same position under all flight conditions, including hovering and idle up. In the AVCS mode, the gyro automatically trims the rudder so that trimming during flight and other precision rudder trim adjustments are unnecessary.

Other precautions

•DS switch setting precaution

When the DS switch is set to the ON position, the rudder servo is driven by approximately 270Hz high-speed pulses. This mode is for use with Futaba digital servos only.

⊘ When using servos that are not compatible with high-speed pulse drive, other than digital servos, never set the DS switch to ON.

The servo may be destroyed.

•Operation of trimmers, etc.

Miniature trimmers and switches are used with the GY401 to reduce its size. When operating the trimmers and switches, always use the miniature screwdriver supplied and do not apply excessive force.

•Servo small step operation

When the model is static, the servos may move a small step. However, this is because the gyro sensitivity is set to a high value and is normal.

One point advice

•Relationship between servo horn length and gyro sensitivity

Gyro sensitivity also changes with the length of the servo horn.

When the sensitivity is too low, length the servo horn. Conversely, when hunting does not stop, shorten the servo horn.

⚠Caution

Mounting Precautions

❗ Always use the accessory sensor tape to install the gyro to the fuselage.

This is necessary to securely fasten the gyro to the fuselage so that operation of the gyro does not transmit unwanted fuselage vibrations directly to the sensor.

❗ When mounting the gyro, provide a little surplus so that the gyro connection cables are not too taut.

If the gyro cables are too taut, the gyro will not display its full performance. If the gyro peels, control will be lost and result in a dangerous situation.

❗ When using the gyro with a helicopter, install the GY401 at least 10cm from the drive motor.

The drive motor generates strong electromagnetic noise. This noise may interfere with the gyro sensor and cause erroneous operation.

❗ Mount the GY401 so that metals or other conductive objects do not touch the gyro case.

The GY401 uses a conductive resin case to reduce electromagnetic interference. Because the surface of the case is conductive, metal objects may cause a short circuit.

❗ Insert the connectors fully.

If a connector works loose due to vibration during flight, control may be lost and result in a dangerous situation.

❗ Always check the direction of operation of the servos.

If you attempt to fly the model when a servo operates in the wrong direction, the fuselage will spin in a fixed direction and enter an extremely dangerous state.

Operation Precautions

⊘ Never move the fuselage for about 3 seconds after turning on the gyro power (shared with receiver).

Since the data inside the gyro is automatically initialized as soon as the power is turned on, if the fuselage is moved, the neutral position will change. If this occurs,

turn the power off and on again. When turning on the power, set the transmitter switch to the AVCS position and turn on the transmitter power switch, then turn on the gyro power.

⊘ Do not operate the rudder trimmer while flying in the AVCS mode.

When the power is turned on, the GY401 assumes that the rudder stick is in the neutral position. If the rudder trimmer is moved during flight, the neutral position will change.

⊘ Avoid sudden temperature changes.

Sudden temperature changes will cause the neutral position to change. For instance, do not fly the model immediately after removing it from inside a heated vehicle in the winter and an air conditioned vehicle in the summer. Let the model stand for about 10 minutes to allow the temperature inside the gyro to stabilize before turning on the power. Also, consider sudden temperature changes when the gyro is exposed to direct sunlight or is installed near the engine. Take measures so that the gyro is not exposed to direct sunlight.

❗ When using the gyro in the AVCS mode, set revolution mixing to 0% or OFF.

In the AVCS mode, all rudder corrections are made by the GY401. Therefore, if rudder mixing is ON, the model will operate the same as if the neutral position changed.

❗ Check the operating time of the receiver, gyro, and servo batteries at the adjustment stage and decide the number of remaining flights while allowing a margin.

Fuselage Maintenance Precautions

⊘ Do not turn the sensitivity trimmer with too much force.

The trimmer may break. Always use the miniature screwdriver supplied to make adjustments.

❗ Make positive maintenance of the fuselage tail section a habit.

The rigidity of the tail section has a large effect on gyro performance. Therefore, loose supporter and tail pipe aging also have a large effect on the characteristics.

❗ Service the fuselage with a little vibration as possible.

Fuselage vibration has a very adverse effect on gyro performance.

Special Markings

Pay special attention to the safety at the parts of this manual that are indicated by the following marks.

Mark	Meaning
⚠ Danger	Procedures which may lead to a dangerous condition and cause death or serious injury to the user if not carried out properly.
⚠ Warning	Procedures which may lead to a dangerous condition or cause death or serious injury to the user if not carried out properly, or procedures where the probability of superficial injury or physical damage is high.
⚠ Caution	Procedures where the possibility of serious injury to the user is small, but there is a danger of injury, or physical damage, if not carried out properly.

Symbol: ⊘ ; Prohibited ❗ ; Mandatory

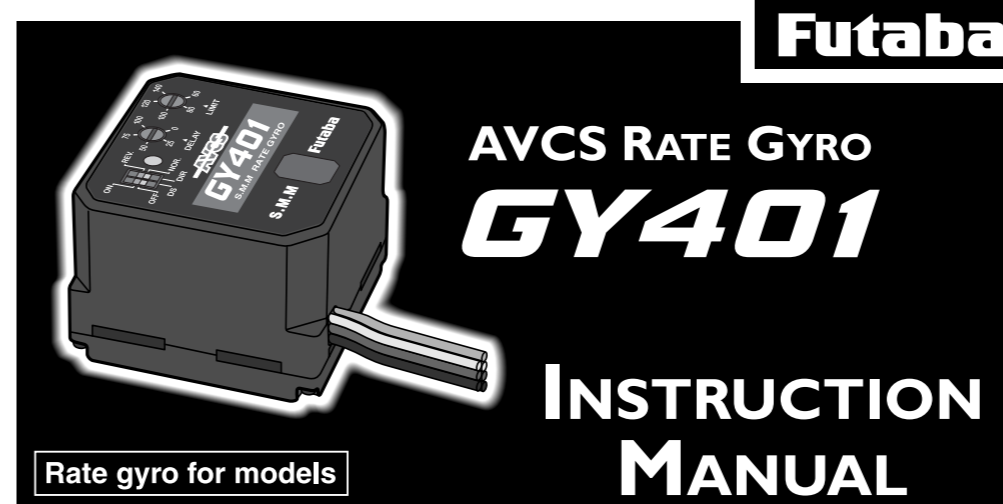

1 FOREWORD

The GY401 is a high performance, compact, light weight AVCS (Angular Vector Control System) gyro developed for model helicopters. Because the sensor and control circuit are integrated, it is simple to install.

Applicable servos

Gyro performance largely depends on the servo used. The higher the speed and response of the servo, the better the gyro sensitivity and performance. From this standpoint, a digital servo is perfect for use with this gyro. The S9253 high-speed digital servo developed especially for gyro use is recommended.

2 FEATURES

•AVCS system

Since rudder trim changes caused by wind and other meteorological changes and front, rear, forward, reverse, and other helicopter attitude changes are automatically cancelled, tail (rudder) operation is easy, making it perfect for 3D flight.

•SMM gyro sensor

Use of newly developed extremely low drift SMM (Silicon Micro Machine) gyro sensor virtually eliminates rudder trim changes during flight.

•Digital servo compatible (DS mode)

DS mode makes it compatible with Futaba digital servos. Maximizes the high-speed response performance of the digital servo.

•Remote gain function and mode switching function

Remote gain function allows sensitivity switching from the transmitter and mode switching function allows AVCS/normal gyro mode switching.

•Integrated, compact, and lightweight

Compact size (27x27x20mm) and light weight (27g) realized by high density mounting technology.

•Conductive resin case

Conductive resin case improves EMC (electrostatic and electromagnetic interference) resistance.

AVCS Gyro

Conventional gyros send control signals to the rudder servo only when the tail of the helicopter moves. When the tail stops moving, the control signal from the gyro becomes zero. Conversely, the AVCS gyro continues to send control signals to the servo even when the tail of the helicopter stops moving.

The following sequentially describes the conventional gyro and the AVCS gyro.

Operation of Conventional Gyro

Basic operation is described by considering the case when the helicopter is hovering under cross-wind conditions. With a conventional gyro, when the helicopter encounters a cross-wind, the force of the cross-wind causes the tail of the helicopter to drift. When the tail drifts, the gyro generates a control signal that stops the drift. When the tail stops drifting, the control signal from the gyro becomes zero. If the cross-

wind continues to cause the tail to drift in this state, the "stop" operation is repeated until the tail faces downwind. This is called the "weathervane" effect.

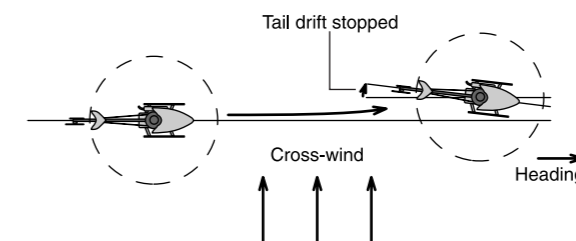

Operation of AVCS Gyro

Conversely, with an AVCS gyro, when the helicopter encounters a cross-wind and the tail drifts, a control signal from the gyro stops the drift. At the same time, the gyro computes the drift angle and constantly outputs a control

signal that resists the cross-wind. Therefore, drifting of the tail can be stopped even if the cross-wind continues to effect the helicopter. In other words, the gyro itself automatically corrects (auto trim) changes in helicopter tail trim by cross-wind.

Considering operation of an AVCS gyro, when the tail of the helicopter rotates, the servo also rotates in accordance with the angle of rotation of the tail. When the tail stops rotating, the servo judges that it has stopped in that position. This is the auto trim function.

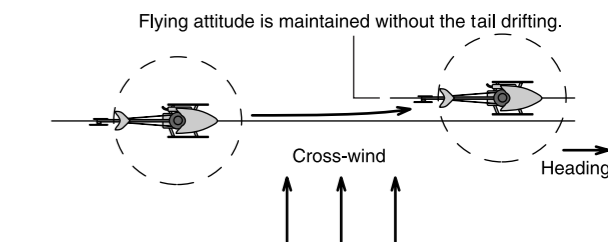

Thank you for buying a GY401 AVCS gyro. Before using your new gyro, please read this manual thoroughly and use the gyro properly and safely. After reading this manual, store it in a safe place.

- No part of this manual may be reproduced in any form without prior permission.
- The contents of this manual are subject to change without prior notice.
- This manual has been carefully written. Please write to Futaba if you feel that any corrections or clarifications should be made.

3 SET CONTENTS

The GY401 comes with the following accessories:

•GY401

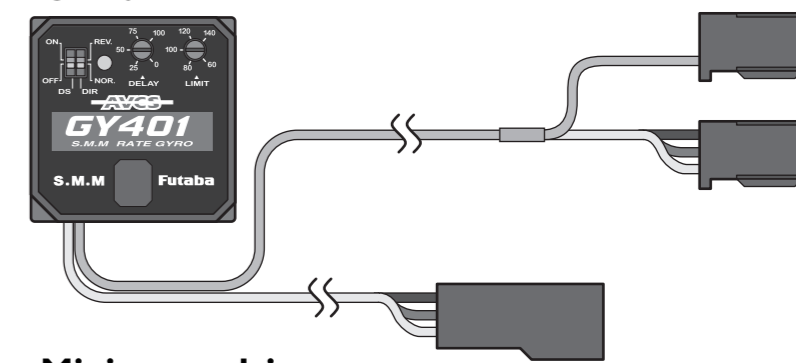

•Mini screwdriver (for adjustments)

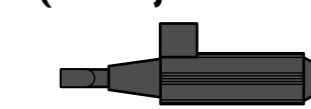

•Double-sided tape (3 sheets)

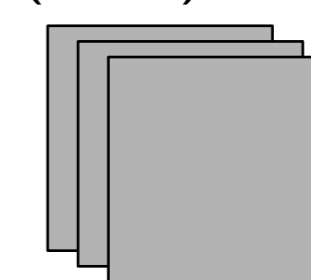

•S9253 (Only a set w/servo)

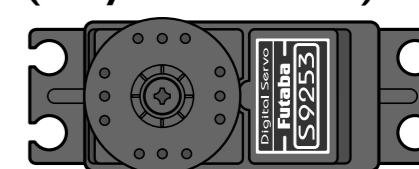

S9253 Ratings

- (Digital servo for gyro)
- Speed: 0.08sec/60° (at 4.8V)
- Torque: 2.0kg-cm (at 4.8V)
- Dimensions: 40x20x36.6mm
- Weight: 49g

GY401 Ratings

- (Integrated sensor type AVCS rate gyro)
- Control system: Digital advanced PI (Proportional Integration) control
- Gyro sensor: SMM (Silicon Micro Machine) system vibration gyro
- Operating voltage: +4 to +6VDC
- Operating temperature range: -10°C to +45°C
- Dimensions: 27 x 27 x 20mm
- Weight: 27g (including connector)
- Functions: Gyro operation direction switch, DS mode switch, Control delay trimmer, Limit trimmer, Remote gain control, AVCS/normal mode switching

4 GY401 FUNCTIONS

Monitor LED

Indicates the operating status of the GY401. The display contents are shown below.

Gyro Operation Direction Switch (DIR)

Switches the gyro control direction. It must be switched according to the direction of rotation of the main rotor and the direction of the rudder linkage. If the rudder servo moves in the cancellation direction when the nose of the helicopter moves, the operating directions are good.

•If you try to fly a model with a clockwise rotation rotor when the gyro operation direction is reversed, the nose will turn to the left and result in a dangerous situation.

DS Mode Switch (DS)

Digital servo (DS) mode switch. The ON position is the high-speed output mode for digital servo only.

When using a normal servo, always set this switch to the OFF position. If it is set to the ON position, the servo will be destroyed.

Control Delay Trimmer (DELAY)

Rudder control signal operation speed trimmer. Conversely, to stop hunting, characteristics can be improved by adjusting the delay. When the trimmer is turned clockwise, the delay increases.

•When using high-speed servos such as a digital servo, set the delay trimmer to "0".

Limit Trimmer (LIMIT)

Sets the maximum travel of the rudder servo. Move the rudder stick to the left and right and adjust the limit trimmer so that the servo operating angle does not strike the linkage. During flight, the servo will not operate beyond this angle and the linkage is protected. When the trimmer is turned clockwise, the servo operating angle increases

Sensitivity Switching Connector

Gyro sensitivity switching signal input connector. Connect to the receiver sensitivity switching channel (normally CH5). This connector is also simultaneously used to switch between the AVCS and normal operation modes. Since this connector is a single wire signal line, do not pull it forcefully.

Rudder Input Connector

Connects to the receiver rudder channel (CH4) output connector.

Rudder Servo Connector

Connects the rudder servo.

(Monitor LED display)

LED display	Gyro operation state
Rapid flash	Displayed while data is being initialized at power ON.
Steady light	Indicates that the gyro is operating in the AVCS mode.
Off	Indicates that the power is OFF, or the gyro is operating in the normal gyro mode.
Slow flash	Displayed when there are no rudder operation signal being input from the transmitter. At this time, the rudder servo does not operate.
Intermittent flash	Alarm display when the power was turned on in the normal gyro mode. For the rudder neutral signal to be read correctly, set the transmitter to the AVCS mode and turn on the gyro power again.
Double flash	Displayed when the rudder signal from the transmitter in the AVCS mode is different from the neutral signal memorized in the gyro. Also flashes when the rudder stick was operated.
Single flash	Displayed only when the transmitter sensitivity switch is rapidly switched between the normal and AVCS positions at least 3 times, then returned to the AVCS position and the transmitter rudder stick was rapidly moved to the left and right at least 3 times. After this display goes off, the rudder is in the neutral position.

Relationship between transmitter sensitivity adjustment and gyro operation sensitivity and operation mode

The gyro sensitivity becomes zero when the transmitter sensitivity switching signal is in the neutral position. The sensitivity can be adjusted over the deflection width of the signal by operating in the AVCS mode at the + side and in the normal gyro mode at the - side of the neutral position.

When the transmitter has a gyro sensitivity switching function (T9ZHwc Series, T8UHPS, etc.), and the transmitter GYRO screen sensitivity setting is 50%, the GY401 gyro sensitivity becomes zero. When the setting exceeds 50%, the gyro enters the AVCS mode and the sensitivity becomes 100% at 100%. At settings lower than 50%, the gyro enters the normal gyro mode and the sensitivity becomes 100% at 0%.

When sensitivity setting is performed by transmitter switch channel, AVCS mode and normal gyro mode switching is performed by switch position. The sensitivity of each mode is set by the rudder angle adjustment function (ATV, AFR, etc.) of the respective channel. When the ATV or AFR set value is 90%, the gyro sensitivity becomes 100%.

Transmitter with gyro sensitivity switching function (T9Zwc, FF8S, etc.)

(Example of sensitivity setting with T8UHPS)

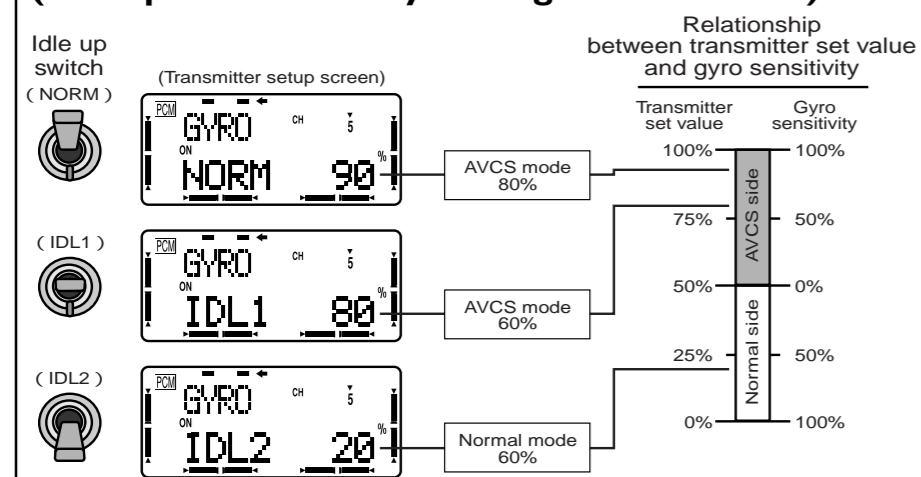

The figure above is an example of use of the gyro sensitivity switching function (GYRO) to switch hovering (AVCS mode), idle up 1 (AVCS mode) and idle up 2 (normal gyro mode) by SW-E and to set the gyro sensitivity to 80%, 60%, and 60%, respectively.

[Setting procedure]

1. Call the transmitter advance menu GYRO setup screen.
2. Press the cursor key and display the switch selection screen. Press the data key and select SW-E.
3. Press the cursor key and display the hovering sensitivity NORM screen and set hovering sensitivity to 90%.
4. Press the cursor key and display the IDL1 screen and set the IDL1 sensitivity to 80%.
5. Press the cursor key and display the IDL2 screen and set the IDL2 sensitivity to 20%.

* The values above are the values when the sensitivity channel reverse function is normal.

Transmitter with ATV function (T9Z, FF8, FF7S, FF6S, etc.)

(Example of sensitivity setting with T6XHS)

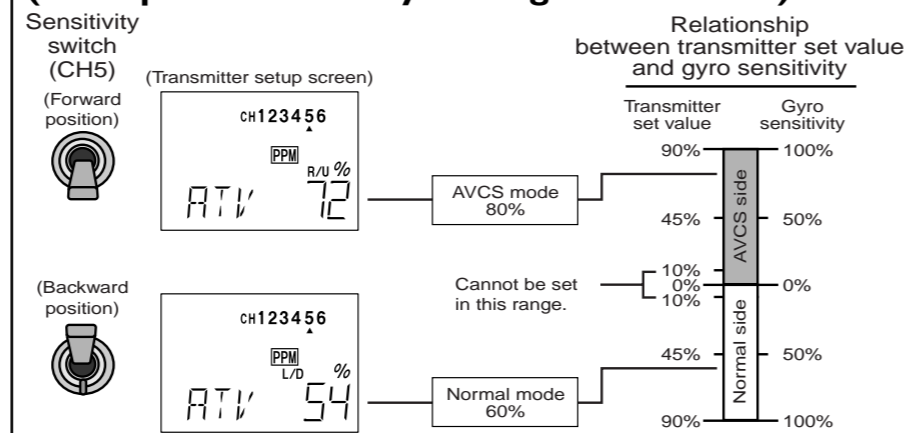

The figure above uses the CH5 ATV function and is an example of switching to hovering (AVCS mode) in the switch forward position and to idle up (normal gyro mode) in the backward position) and setting the sensitivity of each mode to 80% and 60%, respectively.

[Setting procedure]

1. Call the CH5 ATV screen.
2. Pull the CH5 switch forward and set the ATV rate to 72%.
3. Push the CH5 switch backward and set the ATV rate to 54%. However, when sensitivity switching is performed with the CH5 switch, the AVCS mode cannot be used at both hovering and idle up. The AVCS mode and normal gyro mode are switched by switch position.

*The values above are the values when the sensitivity setting channel reverse function is normal.

5 USE

Mount and adjust the GY401 as described below.

Use the miniature screwdriver supplied and operate the GY401 switches and trimmers so that excessive force is not applied.

Installing to fuselage

(1) Gyro installation

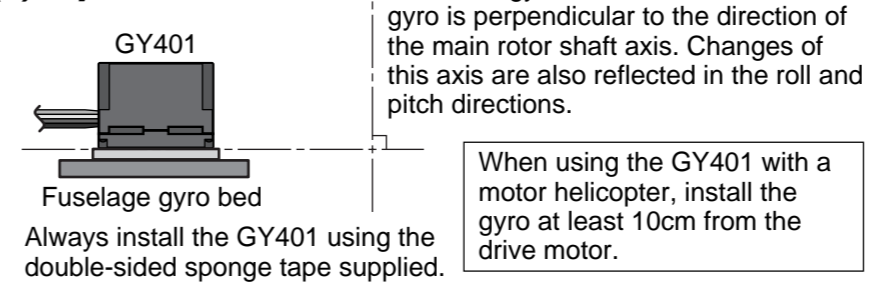

(2) Gyro connection

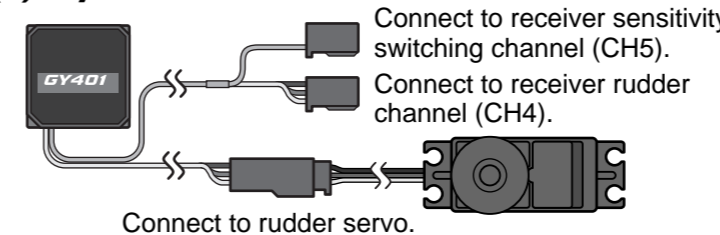

(3) Servo selection

When using a digital servo (S9253, S9250, S9450, etc.) as the rudder servo, set the DS switch to the ON position.

For a digital servo, switch to ON position.

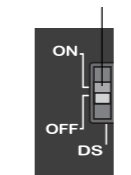

(4) Rudder servo linkage check

Set the transmitter gyro sensitivity switch to the AVCS position and turn on the transmitter power, then turn on the gyro power (shared with receiver). Since the GY401 initializes the data when the power is turned on, set the rudder stick to the neutral position and do not move the helicopter for approximately 3 seconds.

If the monitor LED lights, the gyro is operating in the AVCS mode. When the power is turned on in the normal mode, the monitor LED will display an alarm by flashing intermittently. Set the sensitivity switch to the AVCS position and turn on the gyro power again.

Next, switch the transmitter switch to the normal gyro mode position and check the linkage.

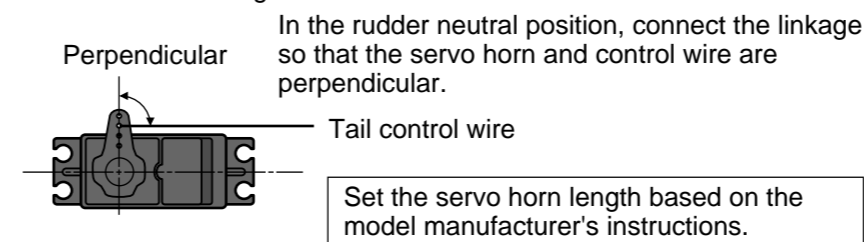

Move the rudder stick to the left and right, and check the direction of operation of the tail rotor. If the tail rotor rotates in the wrong direction, adjust the direction with the transmitter reverse function.

(5) Gyro sensitivity setting criteria

The gyro sensitivity differs with the servos used and the fuselage. Generally, the faster the servo operating speed, the higher the gyro sensitivity. Also, when the main rotor speed is raised, the tail sensitivity of the helicopter itself rises and the gyro sensitivity at idle up must be dropped below the sensitivity when hovering. This tendency is greater with 60 class helicopters than with 30 class helicopters. Start sensitivity adjustment with a gyro sensitivity of 70 ~ 80% when hovering and 60 ~ 70% during flight as the criteria and search for the best sensitivity for the helicopter used.

(6) Gyro operation direction check

If the rudder servo moves to the left when the nose of the helicopter moves to the right, the gyro direction is correct.

If the rudder servo operates in the reverse direction, switch the switch.

Since the switches are close to each other, switch them carefully.

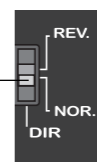

When the rotor rotates clockwise, if you try to fly while the gyro direction is wrong, the nose will rotate to the left and result in a dangerous situation.

(7) Limit setting

Move the rudder stick to the left and right and adjust the limit trimmer so that the servo operating angle does not strike the linkage. During flight, the servo will not operate beyond this limit and the linkage will be protected. If the setting is too low, the gyro performance will be affected.

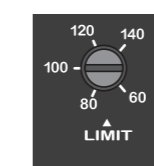

Flight adjustment

In the AVCS mode, the gyro automatically adjusts the rudder neutral position so that mechanical rudder neutral position changes are unknown. When the rudder neutral position changes substantially, a left and right rudder error is generated and gyro performance may drop.

When making your first flight and when reconnecting the linkage, set the mechanical rudder neutral position by first flying in the normal mode and then flying in the AVCS mode.

(Rudder neutral position adjustment)

- (1) Set transmitter revolution mixing (pitch->rudder) to 0% or OFF.
- (2) Set the transmitter gyro sensitivity switch to the AVCS position. First, turn on the transmitter power, then turn on the gyro power (shared with receiver). Since the GY401 initializes the data when the power is turned on, set the rudder stick to the neutral position and do not move the helicopter for approximately 3 seconds.

If the monitor LED lights, the gyro is operating in the AVCS mode.

When the power is turned on in the normal mode, the monitor LED will display an alarm by flashing intermittently. At this time, set the sensitivity switch to the AVCS position and turn on the gyro power again.

- (3) Switch the transmitter gyro sensitivity switch to the normal position. At this time, the monitor LED goes off. Lift off the helicopter and hover and adjust the rudder neutral position with the transmitter trim lever.

Large rudder neutral position deviation may require readjustment of the fuselage linkage.

- (4) Set the gyro sensitivity to the point just before the helicopter tail begins to hunt.

When the helicopter tail hunts, set the gyro sensitivity to a lower value. When adjusting the gyro sensitivity, increase and decrease the sensitivity gradually while checking.

(For other information, see "One point advise".)

This completes mechanical neutral position adjustment. Land the helicopter and set the gyro to the AVCS mode. When flying, the power must always be turned on in the AVCS mode and the rudder neutral position read each time.

(AVCS side adjustment)

- (5) Set the rudder trim position for all flight conditions which use the AVCS mode to the trim position flight-adjusted in the normal mode.

When using common trim in both the AVCS and normal modes, this operation is unnecessary.

When the power is turned on thereafter, the gyro reads this trim position as the rudder neutral position.

- (6) Set the rudder stick to the neutral position, switch the transmitter sensitivity switch between the AVCS and normal modes at least 3 times at an interval of 1 second or less, then set the switch to the AVCS position.

This operation memorizes the AVCS side neutral data to the gyro. At this time, the monitor LED flashes once. The neutral data is also memorized by setting the transmitter sensitivity switch to the AVCS position and turning on the gyro power again.

Switch the transmitter flight mode to hovering, idle up and all other flight conditions used and confirm that the monitor LED lights.

If the LED flashes twice, the rudder trim of that flight condition has shifted. Readjust the rudder.

- (7) Hover and fly in the AVCS mode and set the gyro sensitivity to the point just before hunting begins. The AVCS mode sensitivity is slightly lower than in the normal mode.

When hunting occurs, lower the sensitivity. When adjusting the sensitivity, proceed slowly while checking.

(For other information, see "One point advise".)

- (8) Adjust the rudder steering effect using the transmitter rudder angle adjustment functions (AFR, D/R, etc.).

- (9) When hunting occurs at pirouette stop, increase the delay with the delay trimmer. This hunting occurs easily when the servo operation speed is slow. If the delay is increased too much, the tail will drift when stopping and rudder operation will become sluggish. Adjust the delay to a suitable value.

With a high-speed servo such as the S9253, set the delay trimmer to "0".

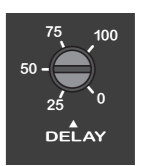

- (10) Switch to the AVCS or normal mode, whichever your prefer. In the AVCS mode, the tail neutral position is forcefully restrained even when external disturbances such as cross winds occur. On the other hand, in flight, the weathervane effect cannot be expected like in the normal mode. When the tail turns, that attitude is maintained. Operation that sets the rudder to a suitable position is required.